



THE MAHATMA GANDHI NATIONAL RURAL EMPLOYMENT GUARANTEE ACT



MANUAL FOR BHARAT NIRMAN RAJIV GANDHI SEVA KENDRA FOR BLOCK AND GRAM PANCHAYAT LEVEL

MINISTRY OF RURAL DEVELOPMENT
GOVERNMENT OF INDIA

डा. सी. पी. जोशी
Dr. C.P. Joshi



ग्रामीण विकास मंत्री एवं
पंचायती राज मंत्री
भारत सरकार,
कृषि भवन, नई दिल्ली-110 114
MINISTER OF RURAL DEVELOPMENT AND
MINISTER OF PANCHAYATI RAJ
GOVERNMENT OF INDIA
KRISHI BHAVAN, NEW DELHI-110 114

MESSAGE

Strengthening the infrastructure at the Gram Panchayat and the Programme Office level to effectively and efficiently implement the Mahatma Gandhi National Rural Employment Guarantee Act has constantly been demanded by States. In due recognition of demands from States, construction of Bharat Nirman Rajiv Gandhi Sewa Kendra has been notified as one of the permissible works under the Act. The Sewa Kendra will provide a platform for the citizens to interact and exchange their experiences and provide logistic support and a record keeping facility centre. The Sewa Kendra will also help in the efficient implementation of the Act at Gram Panchayat and Block levels and in providing space for greater and more transparent interactions with the citizens. Dissemination of technologies and good practices for effecting convergence for sustainable development and productivity enhancement of rural assets is also expected to be done at the Sewa Kendra. The Kendra may be utilized for multifarious functions as detailed in the guidelines issued to the States/Union Territories.

I am sure that this Manual would be useful in explaining the objectives and activities that could be undertaken at the Sewa Kendra as well as in the adoption of designs for the construction of Sewa Kendra at Gram Panchayat and Block level as per the geographical conditions of the State. I urge all implementing agencies to scrupulously adhere to the statutory processes of the Act while constructing the Sewa Kendra. I am sure the construction of Bharat Nirman Rajiv Gandhi Sewa Kendra would meet the long pending demand of the States/Union Territories.

I shall greatly appreciate if the users of this Manual send their comments and suggestions for further improvement.

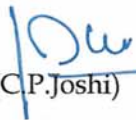
(C.P. Joshi)

प्रदीप जैन 'आदित्य'
PRADEEP JAIN 'ADITYA'



ग्रामीण विकास राज्य मंत्री
भारत सरकार
नई दिल्ली-110011
MINISTER OF STATE FOR RURAL DEVELOPMENT
GOVERNMENT OF INDIA
NEW DELHI-110011

MESSAGE

Panchayats at different levels play an important role in the implementation of rural development schemes. Under Mahatma Gandhi National Rural Employment Guarantee Act, Panchayats are the principal implementing agencies. However, most of the panchayats do not have proper place to efficiently discharge their duties and responsibilities. Inclusion of construction of Bharat Nirman Rajiv Gandhi Sewa Kendra as one of the permissible works under the Act will go a long way in providing a forum for constructive sharing of best and innovative practices to further strengthen implementing process of the Act. Construction of Sewa Kendra would also facilitate better coordination between gram panchayat and block in the implementation of Mahatma Gandhi National Rural Employment Guarantee Act. The Sewa Kendra will serve the twin purposes to provide space for facilitate the functioning of MGNREGS office at both gram panchyat and block levels and to serve as a Knowledge Resource Centre to facilitate different functions as indicated in the guidelines issued by the Ministry of Rural Development.

The Manual outlines in a very lucid manner the objective of the Act, activities that could be undertaken and the different designs for the construction of Sewa Kendra.

I am sure the Sewa Kendra would meet the expectations of the all concerned and would accelerate the effective implementation of the Act in compliance with the statutory processes.

(Pradeep Jain 'Aditya')

सिसिर कुमार अधिकारी
Sisir Kumar Adhikari



ग्रामीण विकास राज्य मंत्री
भारत सरकार
नई दिल्ली-110011
MINISTER OF STATE FOR RURAL DEVELOPMENT
GOVERNMENT OF INDIA
NEW DELHI-110011

MESSAGE

Creation of durable assets is one of the objectives of the Mahatma Gandhi National Rural Employment Guarantee Act. Inclusion of construction of Bharat Nirman Rajiv Gandhi Sewa Kendra is a step in this direction. I hope the Sewa Kendra would enable all MGNREGS workers to better understand exercise of their rights and entitlements and shares their experiences at one place. The Sewa Kendra will bring together all concerned officials at gram Panchayat and block levels to sincerely discharge their constitutional responsibilities and help in strengthening the implementing process of the Act. Citizens will also be benefited with the construction of Sewa Kendra and will get a ready forum to understand their rights and entitlements under the Act. This will also ensure resolving the procedural as well as implementing issues of the citizens,

I am sure the Manual will also be of great interest to the workers as well as general public in better understanding the Mahatma Gandhi National Rural Employment Guarantee Act as well as the genesis for including the construction of Sewa Kendra as the permissible works under the Act.

(Sisir Kumar Adhikari)



अगाथा संगमा
AGATHA SANGMA



ग्रामीण विकास
राज्य मंत्री
भारत सरकार
नई दिल्ली - 110 001
MINISTER OF STATE FOR
RURAL DEVELOPMENT
GOVERNMENT OF INDIA
KRISHI BHAWAN, NEW DELHI-110 001

20.01.2010

MESSAGE

It is another feather in cap of NREGA that the scope of works has included construction of Bharat Nirman Rajiv Gandhi Sewa Kendra at the Gram Panchayat and Block levels which would help to resolve the functional problems and to enable PRIs to discharge their statutory functions in the implementation of the Act.

Sewa Kendras would not only provide a common platform for the citizens to exercise their rights and entitlements under the Act but would also help further strengthening of the statutory implementing processes. In addition, Sewa Kendras will enable PRIs functionaries at Gram Panchayat and Block levels to discharge their responsibilities collectively and effectively in implementing the Act. Besides the above, the Sewa Kendra may also be utilized for the social purposes.

In order to utilize the services of Sewa Kendras to the fullest extent and to achieve their objectives, it has been decided to bring out a Manual which would be of great use to implementing agencies in undertaking their activities as per the laid down procedure in the Act. I wish all success in the efforts of the Ministry.

Agatha Sangma
(Agatha Sangma)

Table of Contents

PART - I

1. The objective of ‘The Mahatma Gandhi National Rural Employment Guarantee Act’	1
1.1. Context	2
1.2. Objectives	2
1.3. Nature of Activities to be undertaken	3
1.4. Designs	5
1.5. Conformity to MGNREGA processes in planning and execution	6
1.6. Funding	7
1.7. Monitoring and Report	7
1.8. Priority	7

PART - II

2. Project Introduction	8
2.1. Project Requirements	8
3. Design Guidelines for BNRGSK at block and Gram Panchayat level	9
3.1. Guidelines for BNRGSK at Block level	9
3.1.1. Floor Plan	9
3.1.2. About the design	10
3.2. Suggestive Architectural forms for BNRGSK at Block level	11
3.2.1. BNRGSK at Block level for Standard General Design	11
3.2.2. BNRGSK at Block level for Hilly Areas (On stilts)	12
3.2.3. BNRGSK at Block level for Coastal Region	13
3.2.4. BNRGSK at Block level for Heavy Rain/Snowfall Areas	14
3.3. Suggestive Architectural forms for BNRGSK at Gram Panchayat Level	15
3.3.1. Site plan(Alternative by COSTFORD on the principles of Laurie Baker)	15
3.3.2. Floor plan(Alternative by COSTFORD on the principles of Laurie Baker)	16
3.3.2. About the design	16
3.3.3. Perspective Views	17
3.3.4. Guidelines developed by the COSTFORD	19
3.3.5. Characteristics of the building developed by the COSTFORD	19
3.4.1. Floor plan	21
3.4.2. About the design	22

3.4.3. BNRGSK at Gram Panchayat level for Standard General Design	23
3.4.4. BNRGSK at Gram Panchayat level for Hilly Areas (On Stilts).....	24
3.4.5. BNRGSK at Gram Panchayat level for Coastal Region	25
3.4.6. BNRGSK. at Gram Panchayat level for Heavy Rain/Snowfall Area.....	26
4.1. Design concepts	27
4.2. Landscaping	28
4.3. Aesthetics.....	28
4.4.1. General design approach for extreme climate.....	29
4.4.2. General design approach for area with heavy rain.....	29
4.4.3. General design approach for structural consideration.....	30
5. General Structure details.....	31
5.1. Details of Filler Slab.....	31
5.2. Typical Structural details.....	32

PART –I

OBJECTIVE OF ‘THE MAHATMA GANDHI NATIONAL RURAL EMPLOYMENT GUARENTEE ACT’

1. The objective of the Mahatma Gandhi National Rural Employment guarantee Act is to provide for the enhancement of livelihood security of the households in rural areas of the country by providing at least one hundred days of guaranteed wage employment in every financial year to every household whose adult members volunteer to do unskilled manual work.

NREGA came into force on 7th September, 2005 and its implementation was notified in phased manner. In phase I, it was introduced in 200 most backward districts of the country on 2nd February 2006. 130 districts were further included under NREGS in phase II with effect from 1st April, 2007. The act was notified in the remaining 274 districts of India from 1st April, 2008. The act is now effective in the entire rural areas of the country covering 618 districts. The Act has recently been renamed as ‘The Mahatma Gandhi National Rural Employment Guarantee Act’ (MGNREGA) vide notification dated 31-12-2009.

The primary objective of the Act is augmenting wage employment. Its auxiliary objective is strengthening natural resource management through works that address causes of chronic poverty, like drought, and so encourage sustainable development.

Para – 1 of Schedule- I of the Act details list of permissible works in the order of priority. Sub Para (9) of the Para – 1 empowers the Central Government to notify any other work in consultation with the State Government. As per Para 2 of Schedule I of the Act, creation of durable assets and strengthening the livelihood resource base of the rural poor shall be an important objective of the Scheme. In conformity with this, Ministry of Rural

Development has expended the scope of permissible work by incorporating construction of Bharat Nirman Rajiv Gandhi Seva Kendra (BNRGSK).

1.1 Context

Ministry of Rural Development, Government of India has expanded the scope of works under schedule1 Para 1(g) to include construction of Bharat Nirman Rajiv Gandhi Seva Kendra (BNRGSK) at the Gram Panchayat (GP) and Block level vide notification no S.O.2877(E) dated 11.11.09. This has been prompted by the demands from several states to strengthen the infrastructure at the Gram Panchayat and the Programme Office level to enable an efficient implementation of MGNREGA and to provide space for greater and more transparent interactions with the citizens.

1.2 Objectives

The objectives of Bharat Nirman Rajiv Gandhi Seva Kendra (BNRGSK) are as follows:

- a) Provide space to facilitate the functioning of the MGNREGA office at the GP/Block levels,
- b) Function as a Knowledge Resource Centre to facilitate
 - i) Citizens access to information on MGNREGA and other Rural Development Programmes
 - ii) Provide space for facilitating dissemination of technologies and good practices for effecting convergence for durability and productivity enhancement of rural assets.
 - iii) Operation of ICT facilities both to support GP and block office of Programme Officer (PO) as well as public excess to information and online transaction related to development process.

1.3 Nature of Activities to be undertaken

The Bharat Nirman Rajiv Gandhi Seva Kendra (BNRGSK) may be used following activities:

- a. Providing space for citizens to exercise their rights under MGNREGA, specially,
 - i) Submit applications for job cards,
 - ii) Submit applications for work,
 - iii) Muster roll scrutiny
 - iv) Complaints
 - v) Use ICT facilities for scrutinizing their rights and entitlements under MGNREGA

A section of the building will be dedicated towards facilitating interactions with MGNREGA workers and local communities.

- b. Providing space for establishing a dedicated office for MGNREGS at the GP and block levels. At the GP level, a section of the building will house the GP Office wherever the GP does not have a building. Where there is adequate infrastructure for the GP, the BNRGSK will be constructed as a citizen-centric Knowledge Resource Centre. As far as possible, this will be structurally connected to the GP building, or near it, to facilitate proper management and control of the resources created for MGNREGA. At the block level, the Programme Officer's office will be located in the BNRGSK building at block level. As far as possible, this will also be structurally connected to the Block building, or near it, to facilitate proper management, coordination and control

of the resources created for MGNREGA. The buildings at both levels should serve the following purposes:

- i) Providing ample space for the functioning of dedicated personnel
 - ii) Enabling meetings, assemblies, gram sabhas at GP level
 - iii) Supporting ICT infrastructure for MIS
 - iv) Maintaining office records,
 - v) Grievance redressal.
 - vi) Enabling social audits at GP level
 - vii) Training and Capacity Building
 - viii) Operationalising ICT based MGNREGS MIS.
 - ix) Providing a single window for information on MGNREGS and other rural development programmes which would ensure transparency and accountability.
- c. BNRGSK as a Knowledge Resource Centre will become the hub for:
- i. Facilitating convergence of all the schemes of rural development, as well as of convergence between RD schemes and other development programmes related to rural areas/communities.
 - ii. Backward and forward linkages, which will be required for convergence for creating more productive and durable assets.
 - iii. Collection and sharing of knowledge, awareness and information about other related schemes for the purpose of convergence.
 - iv. Dissemination and use of new technology
 - v. Capacity building and skill development

1.4 Designs

Structurally, the BNRGSK will reflect two fold objectives:

- a. Infrastructure support for locating the MGNREGA office at the GP and Block levels and strengthening their functioning through appropriate equipment including ICT
- b. Space for interactions with citizens/ local community/MGNREGA workers including enabling citizen access to ICT based information.

This space can also be used for training and resource support to MGNREGA workers, PRIs and beneficiaries of other programmes. These two spaces would be functionally distinct but be interconnected for coordinated use and space optimization. At the GP level, where there is adequate Gram Panchayat infrastructure, the knowledge resource centre section should be constructed and as far as possible, be built in a spatially contiguous area for coordinated resource management.

Proto-type designs the BNRGSK have been developed at the National level as given in this Manual. The prototype designs can be adapted to local conditions, subject to the basic functional spatial concept of the prototype design. The cost norms would be as per the State SoRs and there would be local design variations depending on the geo climatic conditions and the availability of construction material and skills. Designs and detailed manual has been prepared to provide guidance for the construction of BNRGSK. Broadly, the BNRGSK envisages the following structural elements:

- a. At the GP level, there will be a meeting hall to accommodate approximately 50 people, a room to accommodate the GP office requirements and another room for public interface and ICT services. The toilet will be located outside the building.

A stepped, low cost open amphitheatre is proposed near the BNRGSK building to be used for public functions, IEC, large assemblies. On a broad estimate the covered area for the BNRGSK is approximately 130 sq.metre (inclusive of toilet). The overall cost of the GP level BNRGSK should not exceed Rs.10.00 lakh under MGNREGS budget.

- b. At the Block level there will be a meeting hall to accommodate approximately between 80-100 persons, a room to accommodate the Programme Officer's office, another room for public interface and ICT services. The toilet will be located outside the building. The structure should allow future construction on the first floor. On a broad estimate the covered area for the BNRGSK is approximately 290 sq.metre (inclusive of toilet). The overall cost of the Block level BNRGSK should not exceed Rs.25.00 lakh under MGNREGS budget.

1.5 Conformity to MGNREGS processes in planning and execution

The construction of BNRGSK, in so far as it is funded under MGNREGA, will be subject to all MGNREGS processes, through job cardholders, and without the use of machinery and contractor. Muster rolls will be maintained for public scrutiny on site. Clear record should be maintained on the employment generated in the process of construction of BNRGSK. Material procurement will be through a transparent procurement process whose details will be placed on MGNREGA MIS. Wage Material ratio of 60:40 may be maintained at the district level.

1.6 Funding

The source of funding for the construction would be:

- a. For the BRGF districts – the material component may be met from BRGF and the labor component from MGNREGS. In case, the material resource support from BRGF is inadequate, the same can be incurred under MGNREGS provided the material component does not exceed 40% at the district level.
- b. For the non-BRGF districts, MGNREGS would be the main source. The material component can also be supplemented by other schemes.

The maximum expenditure that can be incurred under MGNREGS to construct BNRGSK building at block and Gram Panchayat level would be Rs.25 and Rs.10 lakhs respectively. Expenditure over these ceiling would be borne by the State Governments. The labor material ratio of 60:40 is to be maintained at district level.

1.7 Monitoring and Report

Progress of construction of Bharat Nirman Rajiv Gandhi Seva Kendra will be reflected in the MGNREGA MIS. Concurrent evaluation should be undertaken to assess the quality of the asset created.

The quality of construction and timely completion of Bharat Nirman Rajiv Gandhi Seva Kendra building shall be the responsibility of the District Programme Coordinator. The construction of BNRGSK will be subject to social audit as per MGNREGA.

1.8 Priority

Construction of BNRGSK shall be taken on priority under schedule 1, Para 1(9). A Time-bound Plan for the completion of all BNRGSKs at GP and Block level may also be submitted to the Ministry. Priority as per schedule 1, Para 1(9) may be accorded to the BNRGSK in preparing the shelf of Projects. The Labour Budget should estimate the number of such works planned to be taken up and indicate their location.

PART – II

2. PROJECT INTRODUCTION

The design manual is intended to be explanatory to the design enclosed and covers various aspects of the design. The design has been prepared after studying the requirements of the user, with due consideration to the climatic &, seismic condition, local architectural character and available materials & construction technologies.

2. 1. Project requirement

The major functional elements considered for the BNRGSK at Block level are as follows:

- a. Meeting/Training & capacity building hall
- b. MIS room
- c. Office space with server room
- d. Office space for MGNREGS
- e. Work stations for the employees
- f. Citizen centric interface room
- g. Reception & Lobby
- h. Staircases
- i. External toilet complex

The major functional elements considered for BNRGSK at Gram Panchayat Level are as follows:

- a. Meeting/Training hall
- b. Office space for MGNREGS
- c. Citizen centric interface room

As the building is to be replicated across the country, local bye laws/ development control rules will be followed wherever prevailing. In the absence of any such regulations, the national building codes shall be followed.

3. Design Guidelines for BNRGSK at Block and Gram Panchayat level

3.1. Guidelines for BNRGSK at Block level

3.1.1. Floor plan

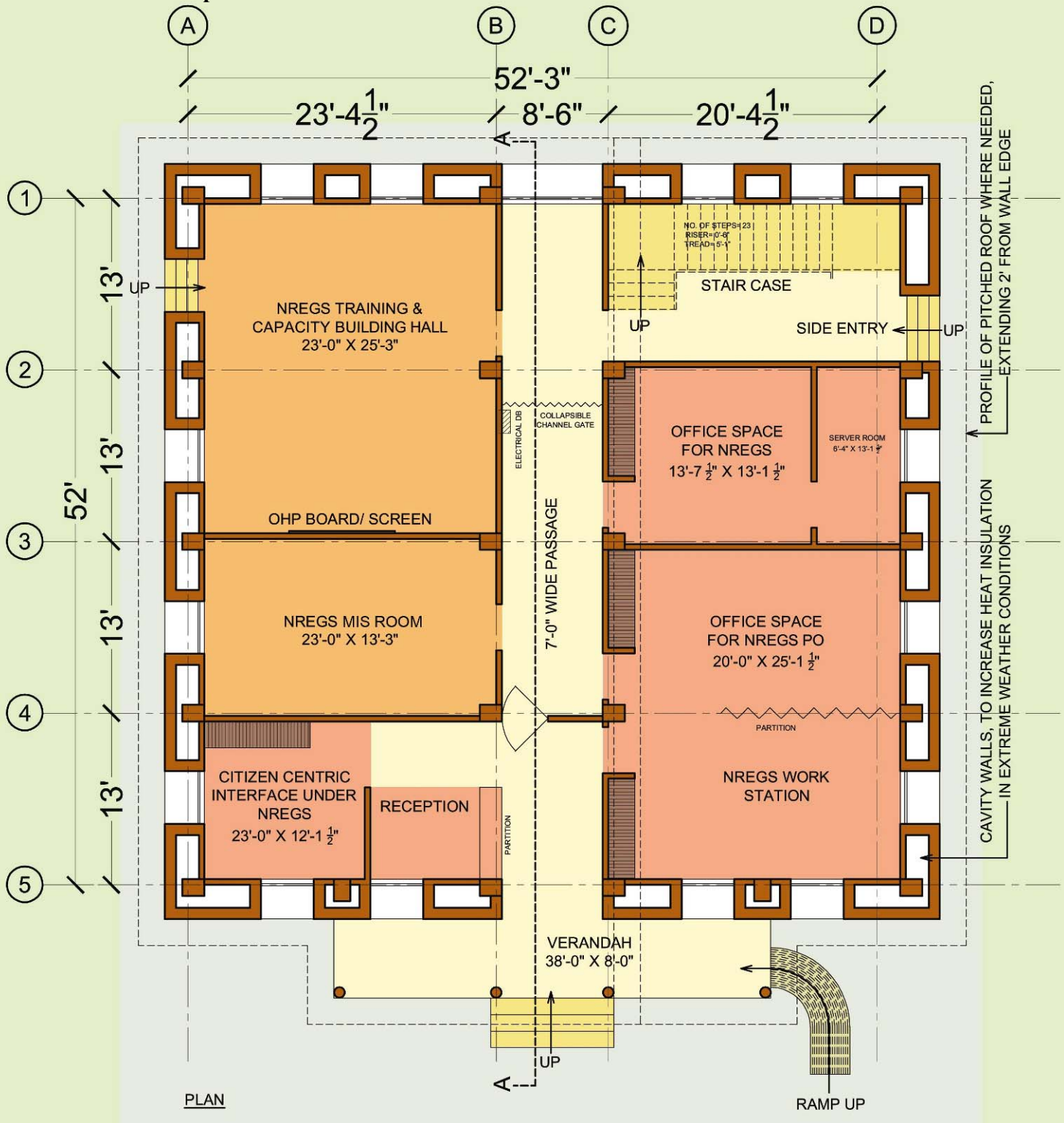

TOTAL AREA = 3358 SQ.FT. / 312 SQ.M.

Fig: 1. Floor plan of BNRGSK at Block Level

3.1.2. About the design

- a. The design has been conceived as a double - storeyed building with multi functional areas with provision for another floor in the future.
- b. The ground floor consists of a covered entrance verandah leading to the reception and the citizen centric interface.
- c. A 7'-0" wide corridor runs through the building with the functional spaces located on both sides. The corridor leads to the staircase at the rear. Windows have been provided at the end of the corridor for natural light & ventilation.
- d. A 600 sq ft training & capacity building hall with projection facilities has been proposed at the rear left side of the building, which can also be used as a 60 capacity conference room.
- e. A MIS room has been proposed near the entrance keeping in mind the thrust of the government towards e-governance.
- f. Office spaces and work station has been proposed on the right hand side of the corridor. The server room is proposed within the office space.
- g. A staircase has been placed at the rear of the building for vertical circulation in the future.
- h. Double or cavity wall construction technology with deep-seated windows has been adopted for insulation in both hot & cold climates.
- i. Provision for differently-abled persons has been provided in the form of ramps.
- j. An external toilet block has been proposed for both the public & office employees.

3.2. Suggestive Architectural forms for BNRGSK at Block level

3.2.1. BNRGSK at Block level (Standard General Design)



Fig: 2. View of Building for Standard General Design

3.2.2. BNRGSK at Block level for Hilly Areas (On Stilts)



Fig: 3. View of Building in Hilly Areas (On Stilts)

3.2.3. BNRGSK at Block level for Coastal Region ('Boat Keel' Roof)



Fig: 4. View of Building in Coastal Region ('Boat Keel' Roof)

3.2.4. BNRGSK at Block level for Heavy Rain/Snowfall Areas



Fig: 5. View of Building for Heavy Rain/Snowfall Areas

3.3.Suggestive layout for BNRGSk at Gram Panchayat Level

3.3.1 Site Plan (Alternative developed by COSTFORD on the Principles of Laurie Baker)

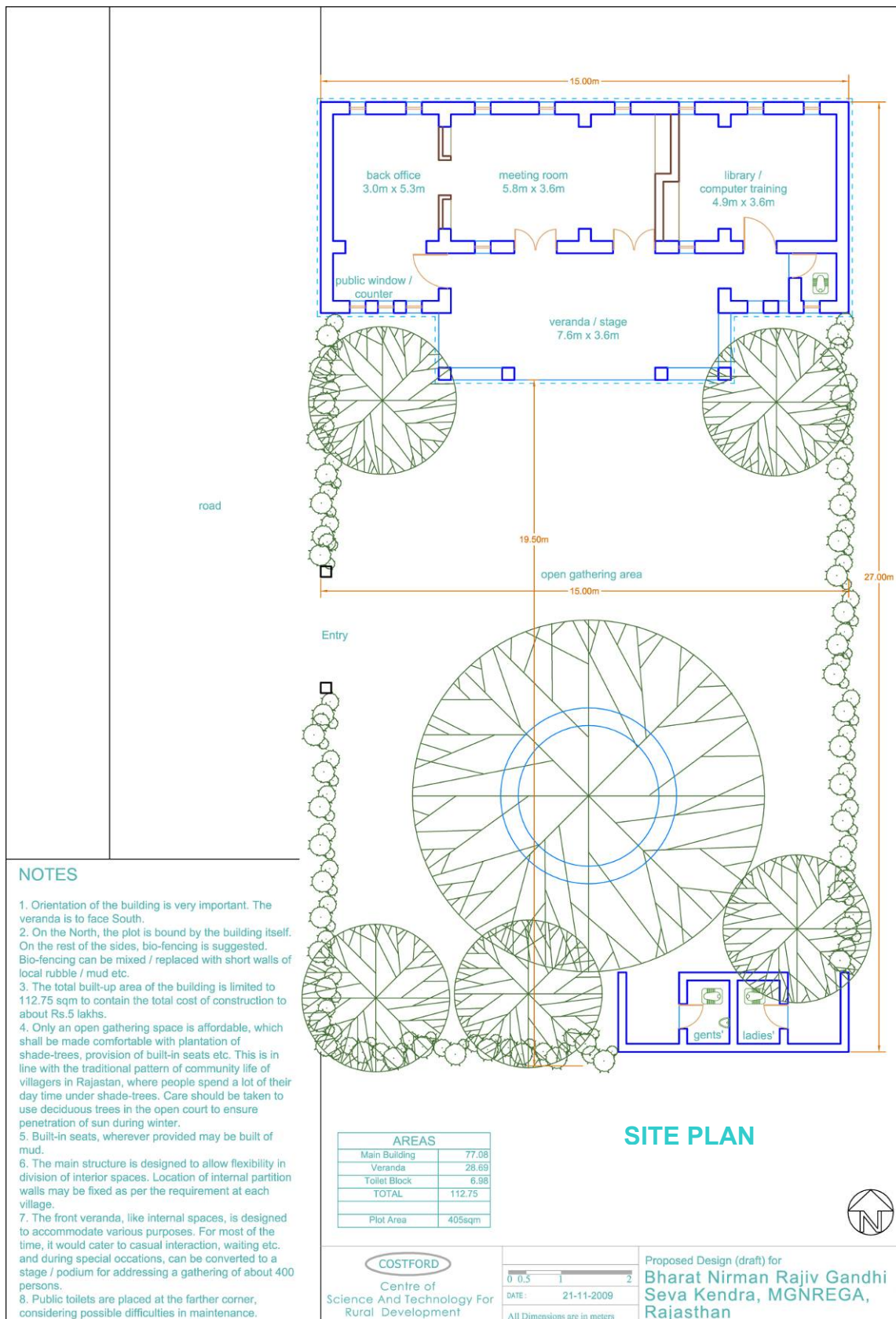

Fig: 6.

3.3.2 Floor Plan (Alternative developed by COSTFORD on the Principles of Laurie Baker)

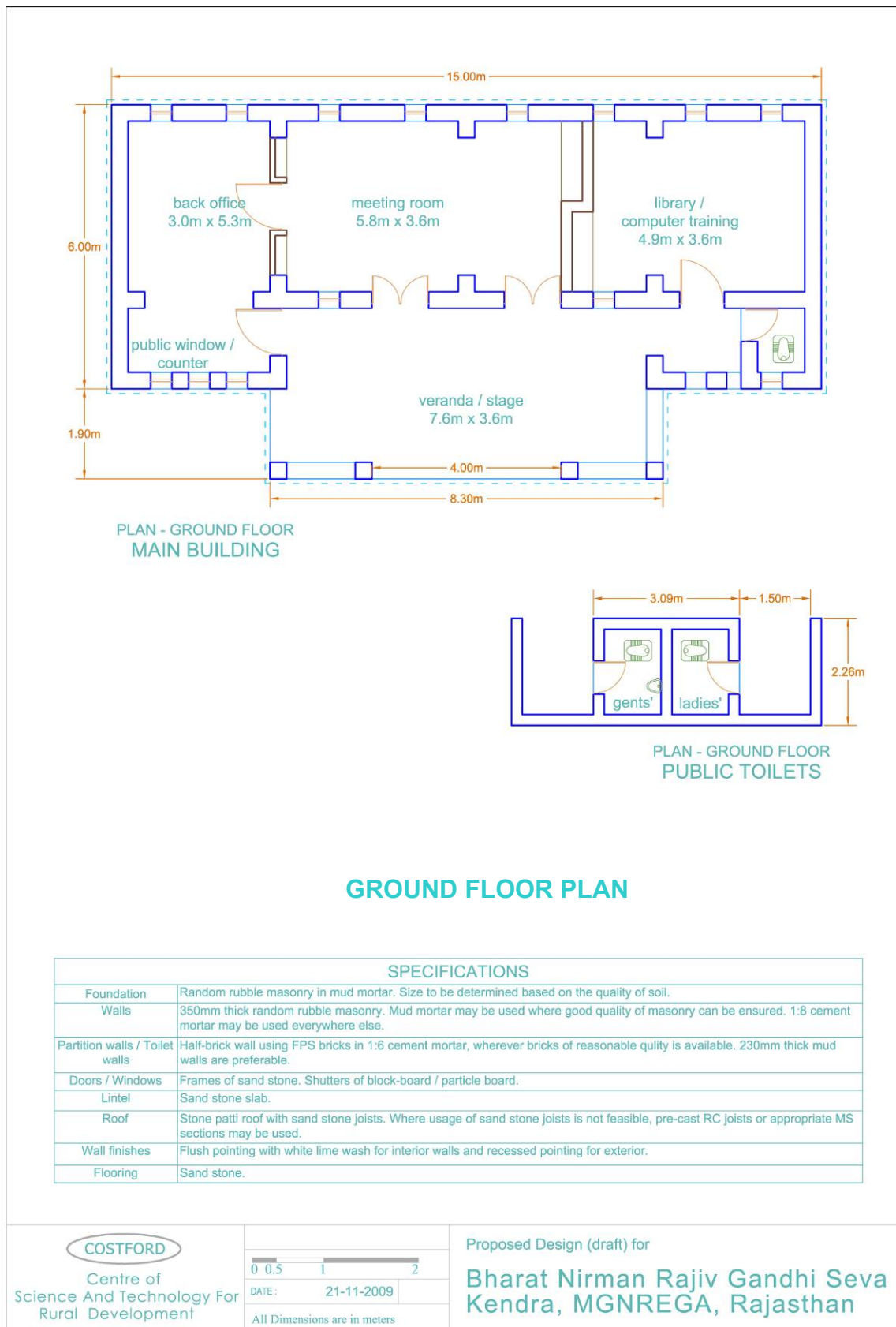

Fig: 7.

3.3.3 Perspective Views (Alternative developed by COSTFORD on the Principles of Laurie Baker)



Fig: 8.



Bharat Nirman Rajiv Gandhi
Seva Kendra

costford

Fig: 9.

3.3.4 Based on the principles of the famous architect, Laurie Baker, following are some important points for the use of local materials to reduce the cost of construction. (Guidelines are developed by the COSTFORD).

1. Reduce cost of construction by the use of stepped foundation.
2. Use a mix of 1:8 cement and coarse sand or locally available clay, instead of 1:6 cement and coarse sand in the foundation
3. Reduce Plinth height.
4. Use locally available stone and coarse sand in masonry work.
5. Use blocks of locally available stone instead of R.C.C. for the construction of the roof.
6. Instead of plastering the outer walls, paint them.
7. Use locally available stone in flooring.
8. Use stone to make door and window sills instead of costly wood.
9. Doors should be of particle board.
10. The building and the toilet should abut the boundary wall to reduce the effective length of boundary wall.
11. Use soak pit with honeycomb brickwork instead of septic tanks for toilets.
12. Construct the main door with wooden jalli instead of iron.
13. Use locally available trees and shrubs in the place of boundary wall.

3.3.5 Characteristics of the building:

1. The verandah along with the waiting space can be used as the stage.
2. The office has a counter along the window to establish direct contact with the visitors.
3. There is enough space within the site for seating of 400 people on special occasions.
4. The building and the toilet should abut the boundary wall to reduce the effective length of boundary wall.
5. The courtyard has a circular pavilion where people can sit and interact.

6. The toilet is kept isolated from the building for easier maintenance.
7. Construction of resting platforms for villagers to take rest.
8. Plantation of trees within the plot, would provide shade and fresh air to the surrounding.

3.4.1. Floor plan (Second Alternative)

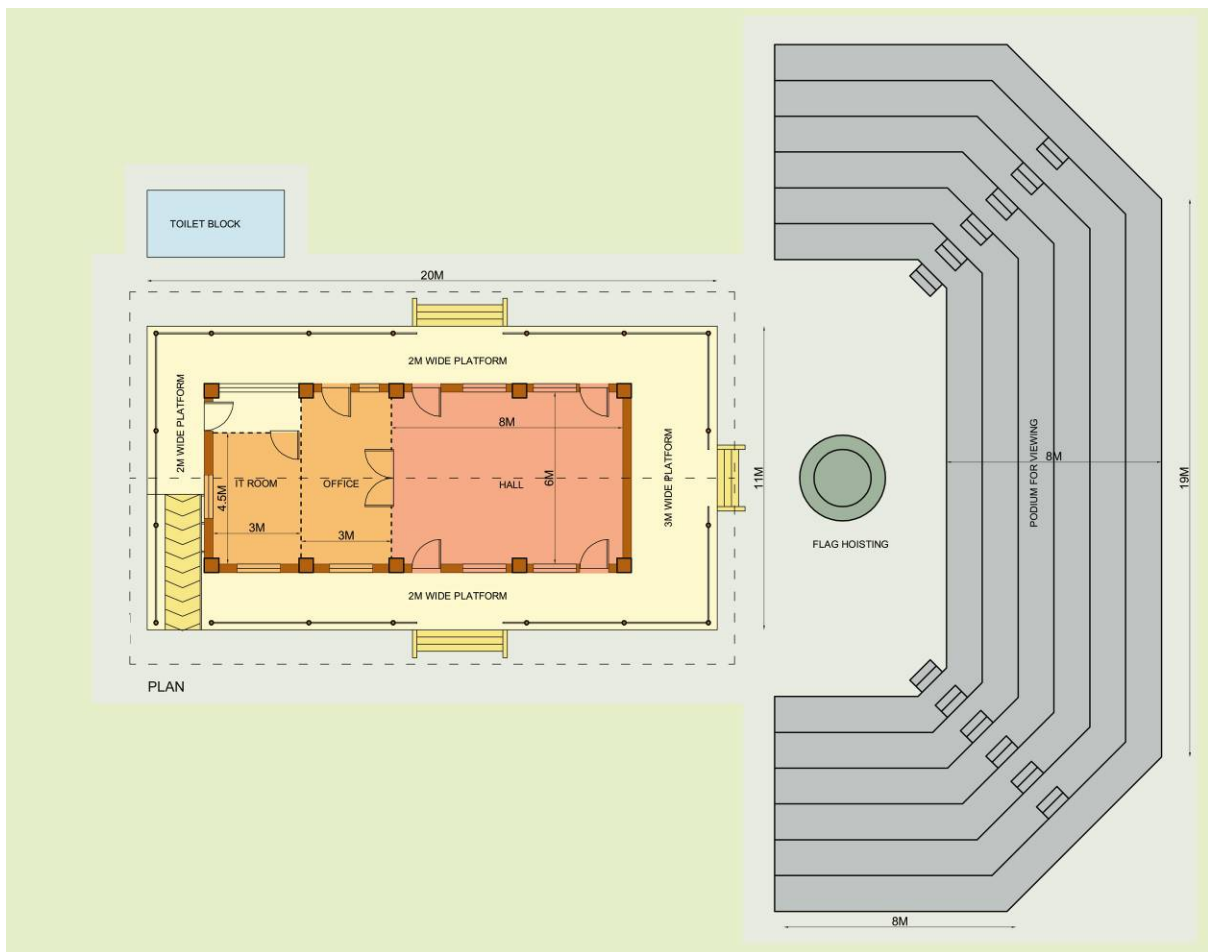

TOTAL AREA OF THE BUILDING = 1060 SQ.FT. / 98 SQ.M.

TOTAL AREA OF OPEN AIR SEATING = 3110 SQ.FT. / 290 SQ.M.

Fig: 10. Floor plan of BNRGSK at Block Level

3.4.2. About the design

9. The gram panchayat level office has been proposed with a 2.0 m wide verandah on three sides & a 3.0m wide verandah opening onto the assembly ground.
10. The building consists of a 400 sq ft training hall with office and IT rooms.
11. The rear verandah of the building opens to an assembly ground with an amphitheatre with seating capacity of 400 persons. General activities like flag hoisting on National days, other meeting activities can be carried out in this area.
12. The verandah and the large roof overhangs protect the building from intense sun & rain, yet allowing the entry of natural sunlight & ventilation.
13. An external toilet block has been proposed for both general public & office employees.
14. The railings shall be of locally available lightweight materials with local architectural features & motifs.

3.4.3. BNRGSK at Gram Panchayat level (Standard General Design)



Fig: 11. View of Building (Standard General Design)

3.4.4. BNRGSK at Gram Panchayat level for Hilly Areas (On Stilts)



Fig: 12. View of Building in Hilly Areas (On Stilts)

3.4.5. BNRGSK at Gram Panchayat level for Coastal Region ('Boat Keel' Roof)

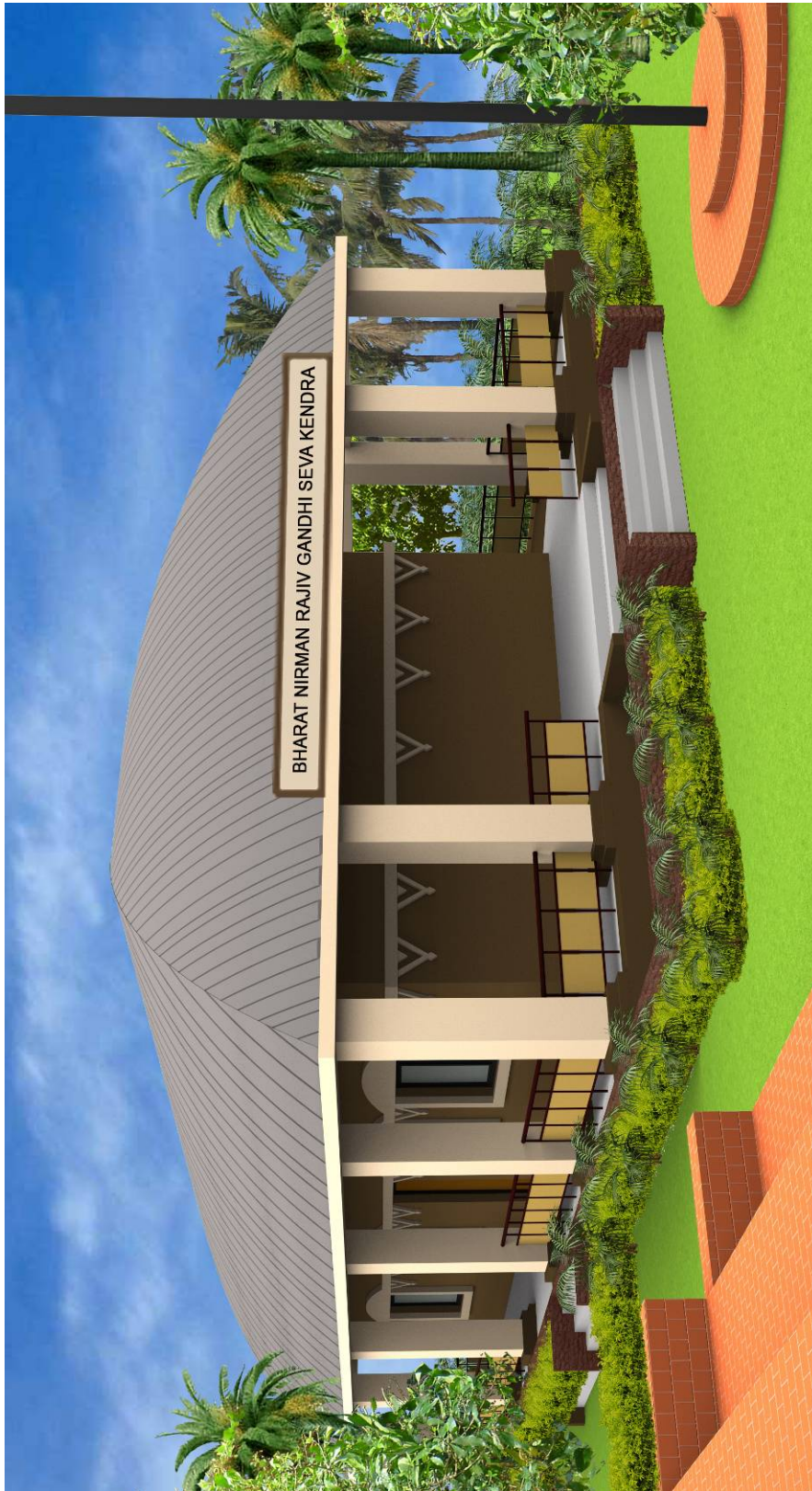

Fig: 13. View of Building in Coastal Region ('Boat Keel' Roof)

3.4.6. BNRGSK at Gram Panchayat level for Heavy Rain/Snowfall Areas



Fig: 14. View of Building in Heavy Rain/Snowfall Areas

4.1. Design Concept

The design concept is based on the project requirements, need of the users, cost effectiveness and the architect's visualization of the project. India being a country with a huge diversity in terms of climatic conditions, culture, heritage, language, soil condition & seismic zones, the basic intention has been to create a design which can be replicated across the country with the use of local architectural material, local construction technology and yet binding the buildings with a common thread and lending them an unique character. The guidelines drawn depend on these determinants so as to encourage best practice in context.

Architecture is largely influenced by

- a. Availability of material
- b. Climatic/Terrain conditions
- c. Local technology
- d. Need/ requirements from the space

This reflects in the designs of the Block and Gram Pachayat Level structures and influences the built envelope. Below mentioned are some general design guidelines that shape the overall framework. However, irrespective of climatic zones, the following are to be considered for contextual, safer and more economic approach

- a. Application of local material and construction technology
- b. Structure to be designed to resist special conditions like seismic and wind load as per standards
- c. Local traditional practices and features to be incorporated wherever applicable
- d. Use of energy efficient technology and systems, like solar and wind energy, energy efficient electrical fittings and fixtures in the building and surroundings.
- e. Rain water Harvesting/ collection and recycling of rain and waste water to be practiced

4. 2. Landscaping

Evergreen trees of local origin will be used for landscaping so that the overall visual impression is of a low-rise environment-friendly building rising from the greenery. Principles of rainwater harvesting are to be applied while site planning to encourage eco-friendly practices.

4.3. Aesthetics

- a. The aesthetics of the design presented lie in creating a distinctive landmark while keeping it sympathetic towards the environment, local ethos and heritage. In doing so, the buildings proposed have a simple footprint yet fulfilling the functional requirements of the user.
- b. The buildings are such that they can be replicated across the length & breadth of the country by using locally available materials, built by local construction technology & yet they will retain their unique architectural characteristics which have been stressed in the concept.
- c. Different types of design have been proposed for various areas covering the entire country.
- d. Sloped roof with skylights have been proposed for regions with high rain/snowfall areas of the country.
- e. The coastal regions are proposed to have 'boat keel' roof with Mangalore tiles roofing. The surface is to be treated with plain waterproof paint of earthen shades.
- f. All the buildings are to be decorated with local architectural motifs & features to the local ethos.

The general design guidelines form the framework by addressing all criteria that are required to be considered while designing and constructing the structures in specific conditions. These take into consideration two broad climatic conditions, landscaping and site development, criteria that pertain to aesthetics and consideration of seismic design.

4.4.1. General design approach for extreme climate (hot and cold)

- a. Structure should be shaded, especially on the western side for climate control
- b. Flooring to be constructed of local material and should be insulated
- c. Opening to be of smaller size and shaded to maintain indoor temperature
- d. Construction of cavity walls for efficient insulation against heat and cold. Interior of cavity wall can be used as storage space.
- e. Adoption of lime-terracing for controlling of indoor temperature
- f. Khus-khus or louvers to be used as covering of openings for controlling indoor temperature in extreme hot climatic zones
- g. Local traditional practices and features to be incorporated wherever possible
- h. Adequate rainwater disposal system and harvesting wherever practicable

4.4.2. General design approach for areas with heavy rain

- a. Adequate cross-ventilation to counter humidity and high temperature
- b. Large planned openings to channelize air. Area and size of opening to be proportionate to the area of room, as per standards. Louvered openings in hot humid areas encourage efficient channelization of air
- c. Higher floor heights to enhance climate control
- d. Use of sloping roof to dispel rainwater effectively
- e. Appropriate increased plinth height to avoid flooding

- f. Construction of cavity walls especially in areas of high humidity
- g. Adequate rainwater disposal system and harvesting wherever practicable

4.4.3. General design approach for structure considerations

- a. Brick walls should be of minimum 230/250 mm thickness.
- b. Locally available stone/rubble masonry shall be used as far as possible
- c. Foundations should be placed on hard soil at least 1200 mm below ground level. (As shown in sketch 5.2.1)
- d. Plinth, Lintel and Roof bands of RCC shall be provided in all structures (as shown in sketch 5.2.3, 5.2.4 and 5.2.5)
- e. Reinforcement shall be provided in corner of brick walls/openings as shown in sketch 5.2.2)
- f. RCC Beams and columns shall have seismic design and reinforcement detailing as per National Disaster Management Authority guidelines & various other IS code provision (as shown in sketch 5.2.6 & 5.2.7)
- g. Roof slab shall be made of 'Filler Slab' wherever possible to reduce cost and increase insulation. (As explained in 5.1)

5. General Structural details

5.1. Details of Filler Slab

This is a cost-effective roofing system, which is principally based on the concept that for a simply-supported slab, concrete below the neutral axis takes no tension and is hence an unnecessary waste; this can be replaced by clay tiles to act as fillers within the slab. The steel in this zone bears the tensile forces while the concrete is retained above the neutral axis, since it can take compressive loads very effectively.

The use of less of concrete and less of steel is owing to the fact that the dead load of the slab is considerably reduced. This also results in less of load getting transferred to the load-bearing walls and the foundations. Apart from this, the air gap in between the tiles makes it a good heat insulator and the ceiling looks attractive as well.

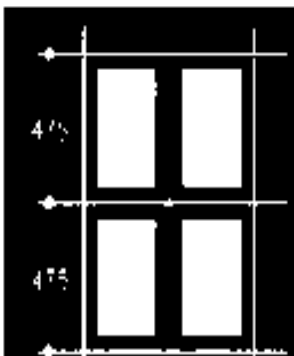

Fig: 12. View of arrangement of Tiles between the reinforcement



Fig: 13. Photograph shows the arrangement of Mangalore tiles.



Fig: 14. Photograph shows the arrangement of Mangalore tiles.

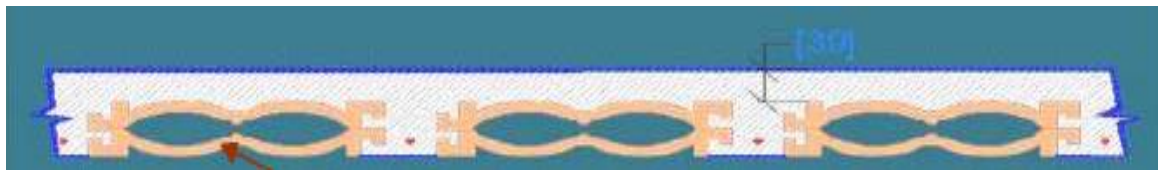
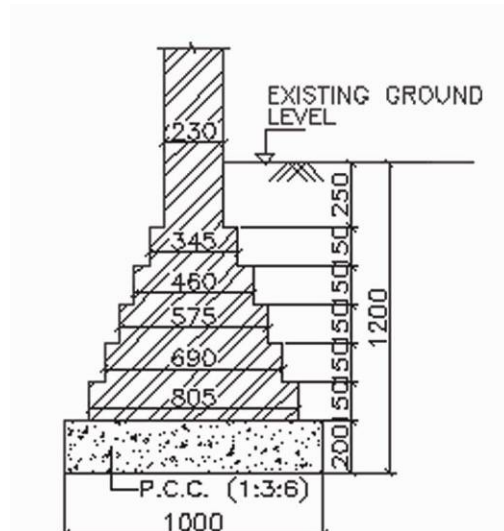

Fig: 15. Sectional view of slab

5.2. Typical Structural details

5.2.1 Typical Details of Brick Foundation



TYPICAL DETAIL OF WALL FOOTING

5.2.2 Details of corner junctions

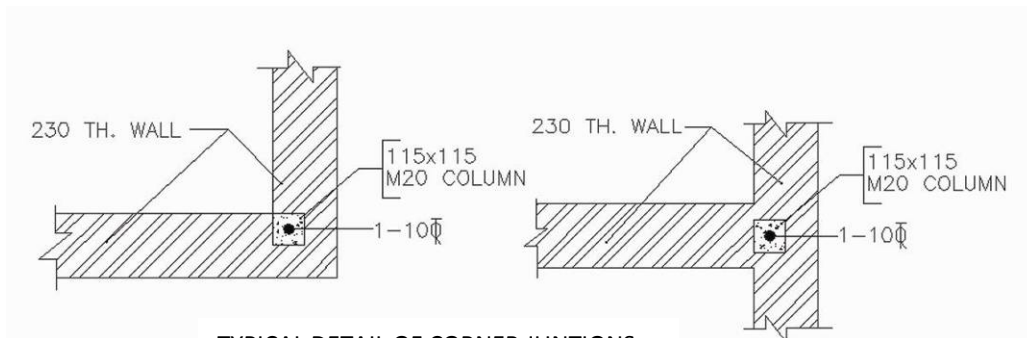

TYPICAL DETAIL OF CORNER JUNCTIONS

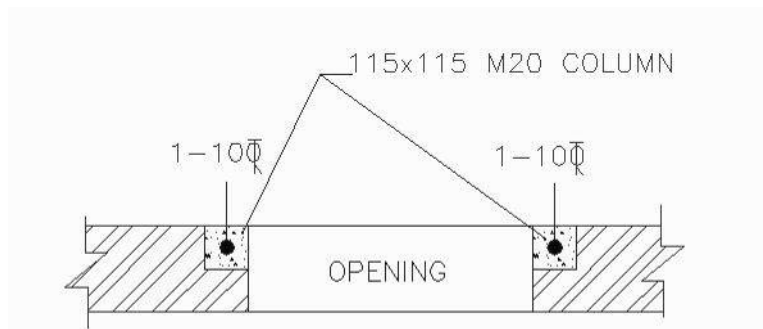

TYPICAL DETAIL OF CLOUMN AROUND OPENING

5.2.3. Details of Plinth, Lintel and Roof Band

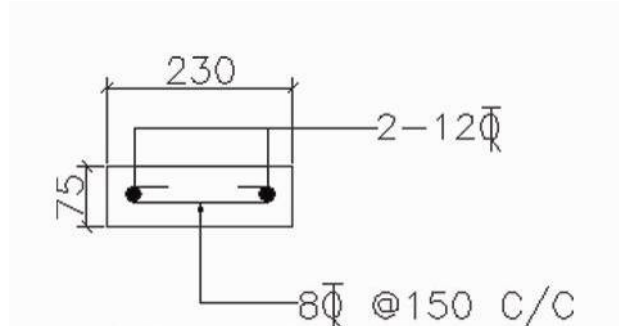

TYPICAL DETAIL OF BAND AT PLINTH, LINTEL AND ROOF LEVEL

5.2.4 Positioning of building components

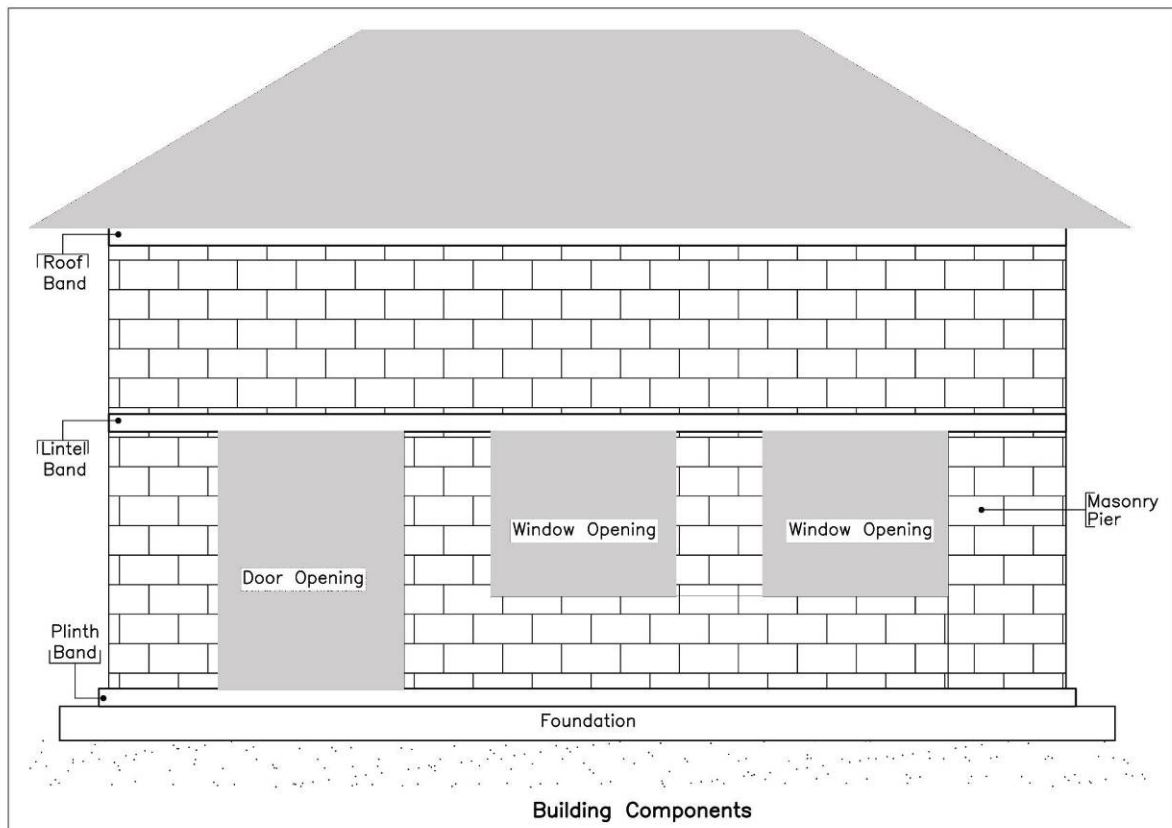

5.2.5 Preferred type of reinf position in bands

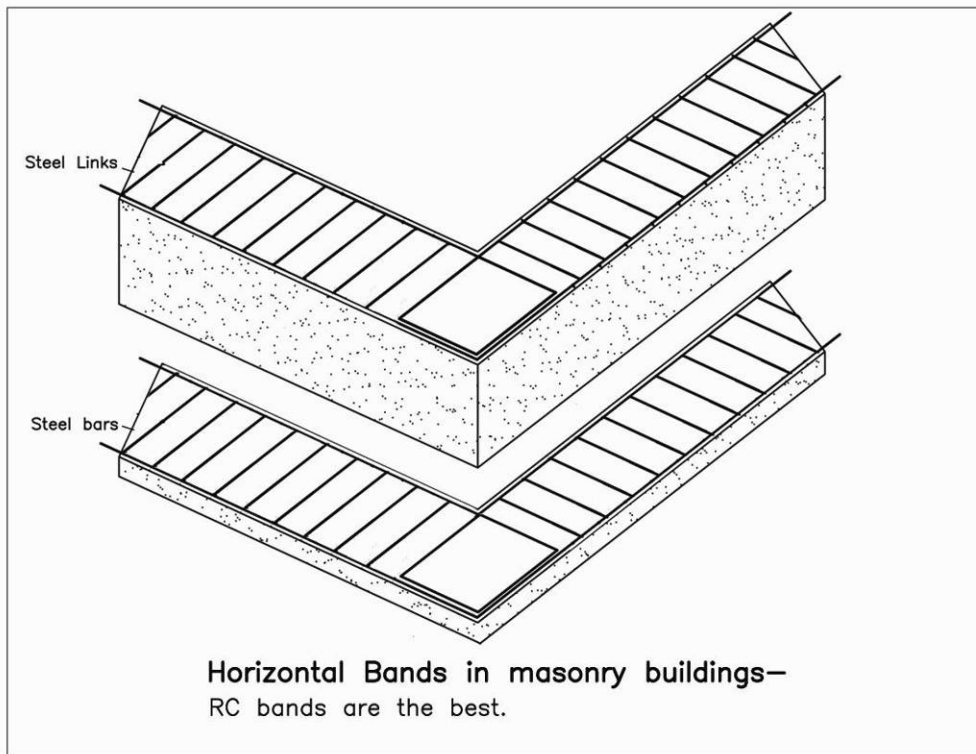

5.2.6 Details of lapping in seismic beams

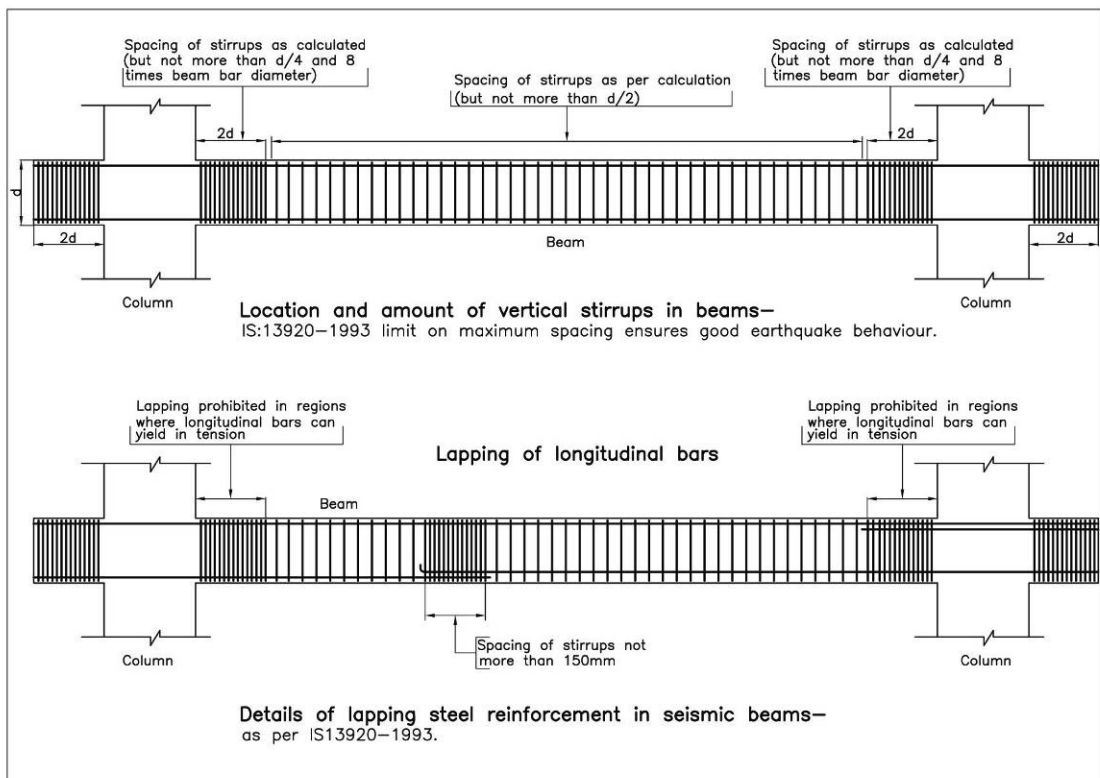

5.2.7 Column details for seismic structures

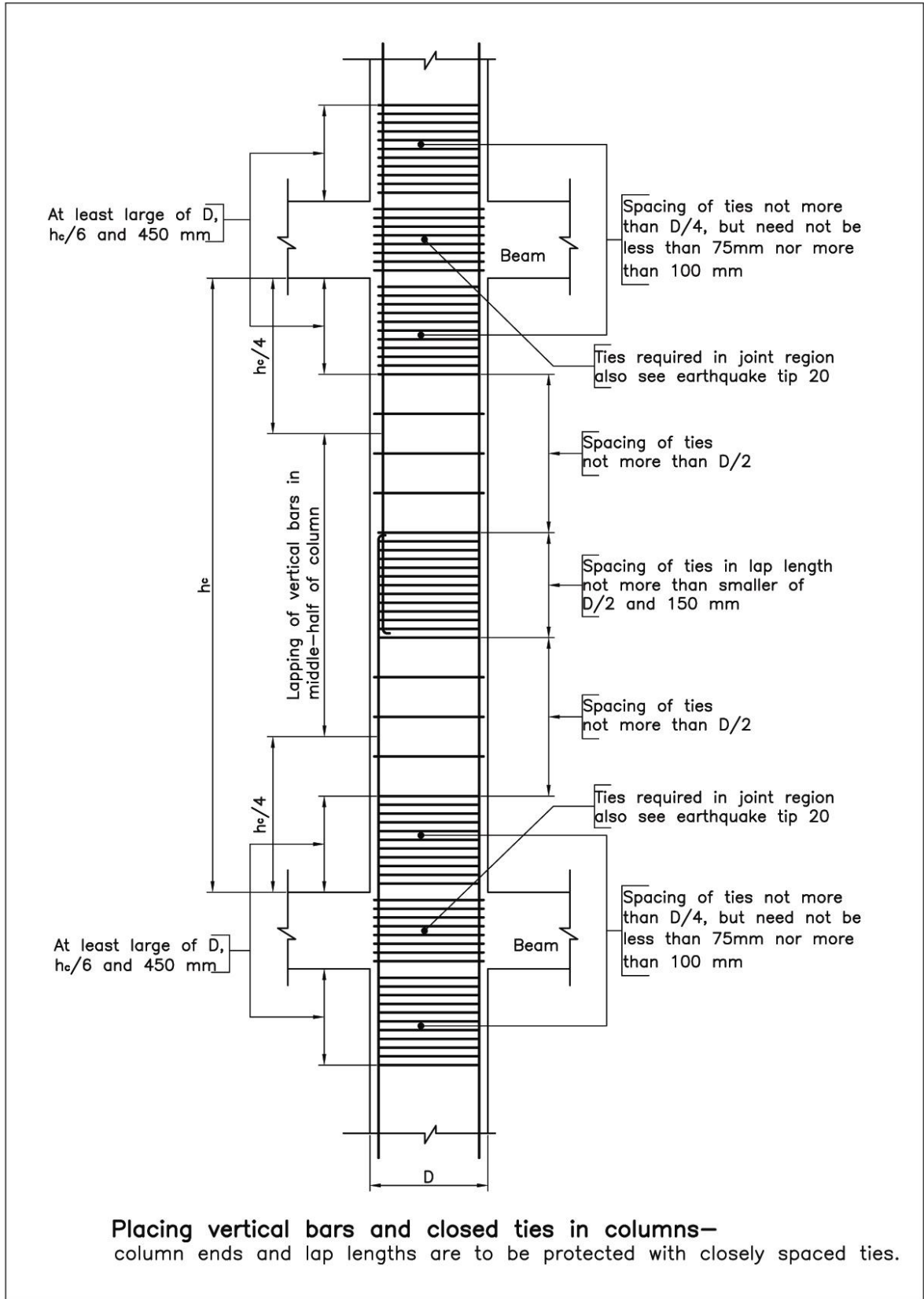

Acknowledgements

National Buildings Construction Corporation Ltd.
(A Government of India Enterprise)
Spl. Proj. Zone,
JMC, NBCC Bhawan, Lodhi Road
New Delhi- 110003
Phone- 011-24368677
Email- bahal.rajesh@gmail.com

COSTFORD
Centre of Science and Technology for Rural Development
Shri P. B. Sajan, Joint Director
C/O The Hamlet
Benedict Nagar, Nalanchira
Trivandrum- 695015
Kerala
Phone- 0471-2530031, 09447150810
Email- costfordtvm@gmail.com

Axis Consultants
H- 1517 Chittaranjan Park
New Delhi- 110019
Phone- 011-26270465
Email- axis_consultants@yahoo.com